

2

CLIQUETS ET DOUVILLES

Pour un serrage performant
en carré 1/4" jusqu'à 1"



CLIQUETS ET DOUILLES 1/4"

CLIQUETS

CLIQUET FAST 1/4"



Cliquet Premium FAST. Couronne pour rotation à la main. Pratique en début de vissage.

PERFORMANCE

- 72 dents.

ACCESSIBILITÉ

- Angle de reprise de 5° pour des espaces réduits.

ERGONOMIE

- Manche confortable bimatière :
 - polypropylène pour plus de résistance,
 - élastomère pour une bonne prise en main.
- Étudié pour travailler dans toutes les positions : liaison corps-manche du cliquet, pour ne pas gêner la main lors de la prise.
- Forme en bout pour une saisie en extrémité facilitée et une bonne tenue dans la paume.

PRATIQUE

- Changement de sens par rotation sur toute la circonférence de la tête.

SÉCURITÉ DU TRAVAIL

- Verrouillage et déverrouillage rapides des douilles par bouton poussoir d'éjection.

Fabrication en acier Chrome-Vanadium, le meilleur matériau pour la fabrication de douilles et cliquets. Duretés : de 42HRC +/-2. Rapport dureté/longévité optimum.



CLIQUET FAST 1/4"

Couronne pour rotation à la main. Pratique en début de vissage. 72 dents. Bouton d'éjection. Manche bimatière.



L mm	ØD mm	H mm	g	Ref.	Ref.	EAN 330380+
138	26	28	120	9200721301	1	9201744

Repair

NE JETEZ PLUS, RÉPAREZ !

Prolonger la durée d'usage en réparant permet de réduire notre empreinte environnementale tout en diminuant la quantité de déchets produits. C'est ainsi une belle manière d'œuvrer pour le futur.

KIT RÉPARATION CLIQUET FAST 1/4"

7 pièces + graisse permettant la réparation du cliquet.

Ref.	Ref.	EAN 330380+
92007203K1	1	9201768

CLIQUET 1/4" ROND ET POIRE



SÉCURITÉ DU TRAVAIL

- Verrouillage et déverrouillage rapides des douilles par bouton poussoir.
- Les douilles ou les accessoires ne se désolidarisent pas du cliquet.

ACCESSIBILITÉ

- L'angle de rotation de 5° (cliquet à 72 dents) assure une reprise très performante dans des espaces réduits.
- Les têtes des cliquets ont un encombrement réduit pour offrir l'accessibilité maximale.

ERGONOMIE

- Manche confortable bimatière étudié pour travailler dans toutes les positions :
 - Le polypropylène pour plus de résistance.
 - L'élastomère pour une bonne prise en main.
- Liaison corps-manche du cliquet étudiée pour ne pas gêner la main lors de la prise.

2 MODÈLES

- Cliquet rond : le changement du sens de serrage se réalise facilement avec le pouce sur toute la circonférence de la tête. C'est la référence en France chez les Pros.
- Cliquet poire : le changement se fait par levier intégré. La position du levier donne de façon visible le sens de serrage.

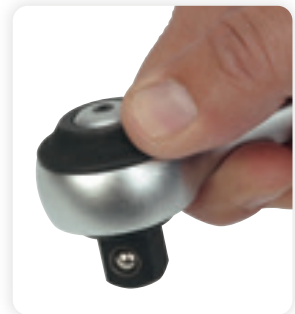

CLIQUET MICRO 1/4"



72 dents. Bouton d'éjection. Changement de sens par rotation sur toute la circonférence de la tête. Manche bimatière.



L mm	ØD mm	H mm	g	Ref.	Ref.	EAN 330380+
138	26	28	115	9200720001	1	9200723

CLIQUET MICRO 1/4" SUR CARTE

72 dents. Bouton d'éjection. Changement de sens par rotation sur toute la circonférence de la tête. Manche bimatière.



L mm	ØD mm	H mm	g	Ref.	Ref.	EAN 330380+
138	26	28	115	9200721001	1	9200006

KIT RÉPARATION CLIQUET ROND 1/4"

Pièces permettant la réparation du cliquet.

g	Ref.	EAN 330380+
50	92007200K1	9201751

CLIQUET POIRE 1/4"



72 dents. Bouton d'éjection. Levier de changement de sens intégré dans la tête. Le sens est donné par la position du levier. Manche bimatière.



L mm	D mm	H mm	g	Ref.	Ref.	EAN 330380+
143	26	12,5	130	9200720101	1	9200730

CLIQUET POIRE 1/4" SUR CARTE

72 dents. Bouton d'éjection. Levier de changement de sens intégré dans la tête. Le sens est donné par la position du levier. Manche bimatière.



L mm	ØD mm	H mm	g	Ref.	Ref.	EAN 330380+
143	26	12,5	130	9200721101	1	9010209



9



69



103



129



133



155



187



197



223



231



257



273



277



283

CLIQUETS ET DOUILLES 1/4"

CLIQUETS

CLIQUET TÊTE ROTATIVE 1/4"



TÊTE ROTATIVE LIBREMENT ORIENTABLE

- Utilisable comme un tournevis classique en position 0°.
- Utile lorsque la situation nécessite un dégagement.
- Utilisable en cliquet classique à 90°.

ACCESSIBILITÉ

- Cliquet de 100 dents.
- Angle de rotation de 3,6°.

SÉCURITÉ DU TRAVAIL

- Verrouillage et déverrouillage rapides des douilles par bouton poussoir.
- Les douilles ou les accessoires ne se désolidarisent pas du cliquet.

ERGONOMIE

Le changement de sens de serrage se réalise facilement avec le pouce sur toute la circonférence de la tête.

MANCHE BIMATIÈRE

Manche confortable bimatière étudié pour travailler dans toutes les positions.

Âme en polypropylène pour plus de résistance et grip en élastomère pour une bonne prise en main.



CLIQUET TÊTE ROTATIVE 1/4"

100 dents. Bouton d'éjection. Changement de sens par rotation sur toute la circonférence de la tête. Manche bimatière.



L mm
153

D mm
32

H mm
26

g
145

Ref.
9200100001

1

EAN 330380+
9013040

DOUILLES 1/4"



RÉSISTANCE

La suppression des angles vifs des carrés augmente leur résistance.

ERGONOMIE

- Manipulation des douilles est rendue facile grâce à un épaulement extérieur prévu pour la prise.
- Pour trouver rapidement la douille souhaitée sa dimension est marquée sur tout le pourtour.

Mob propose deux gammes de douilles :

- 6 pans pour serrages puissants.
- 12 pans pour la mise en place et la reprise facile dans les endroits encombrés.

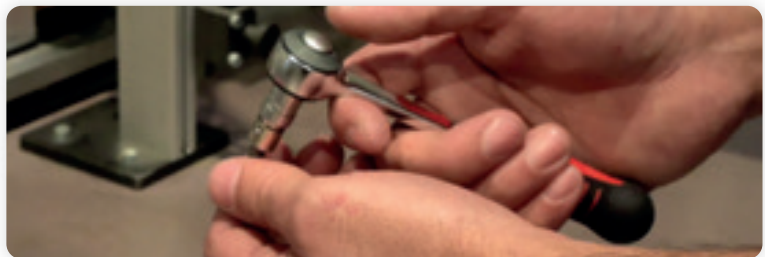

DOUILLE 6 PANS 1/4"

NF ISO 2725 - DIN 3124

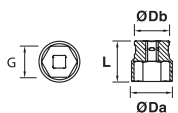

DOUILLE 6 PANS 1/4" SUR CARTE

NF ISO 2725 - DIN 3124



Dim mm	ØDb mm	ØDa mm	L mm	g	Ref.	Ref.	EAN 330380+
4	11,85	6,8	25	9	9210040001	5	9210043
5	11,85	8	25	10	9210050001	5	9210050
5,5	11,85	8,7	25	10	9210A50001	5	9210555
6	11,85	9,3	25	11	9210060001	5	9210067
7	11,85	10,8	25	11	9210070001	5	9210074
8	11,85	11,5	25	11	9210080001	5	9210081
9	12	12,85	25	12	9210090001	5	9210098
10	12	14,35	25	17	9210100001	5	9210104
11	14	15,85	25	17	9210110001	5	9210111
12	14	16,85	25	18	9210120001	5	9210128
13	14	17,85	25	24	9210130001	5	9210135
14	14	19,7	25	28	9210140001	5	9210142

Dim mm	ØDb mm	ØDa mm	L mm	g	Ref.	Ref.	EAN 330380+
7	11,85	10,8	25	11	9210071001	3	9210197
8	11,85	11,5	25	11	9210081001	3	9210203
10	12	14,35	25	17	9210101001	3	9210227
11	14	15,85	25	17	9210111001	3	9210234
12	14	16,85	25	18	9210121001	3	9210241
13	14	17,85	25	24	9210131001	3	9210258



9



69



103



129



133



155



187



197



223



231



257



273



277



283

CLIQUETS ET DOUILLES 1/4"

DOUILLES ET ACCESSOIRES

DOUILLE 6 PANS 1/4" EN POUCES

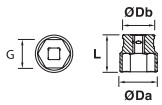

Dim. pouces	ØDb mm	ØDa mm	L mm	g	Ref.	Ref.	EAN 330380+
3/8	12	12,85	25	12	9210120101	5	9012562
7/16	14	15,85	25	15	9210140101	5	9012579

RACKS DE DOUILLES 1/4" 12 PIÈCES

4 à 14 mm - 6 pans

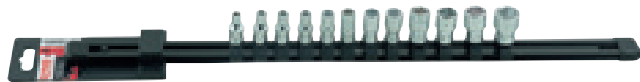

Pans	Contenu	L mm	g	Ref.	Ref.	EAN 330380+
6	4-5-5.5-6-7-8-9-10-11-12-13-14 mm	483	296	9481012001	1	0010956

DOUILLE 12 PANS 1/4"

NF ISO 2725 - DIN 3124

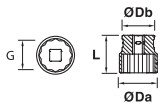

Dim mm	ØDb mm	ØDa mm	L mm	g	Ref.	Ref.	EAN 330380+
3,2	11,85	6	25	9	9216C30001	5	9216038
4,5	11,85	7,4	25	10	9216B40001	5	9216014
5	11,85	8	25	10	9216050001	5	9216052
5,5	11,85	8,7	25	10	9216A50001	5	9216557
8	11,85	11,5	25	11	9216080001	5	9216083
10	12	14,35	25	17	9216100001	5	9216106
11	14	15,85	25	17	9216110001	5	9216113
13	14	17,85	25	24	9216130001	5	9216137

DOUILLES 12 PANS 1/4" EN POUCES

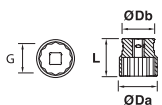

Dim. pouces	ØDb mm	ØDa mm	L mm	g	Ref.	Ref.	EAN 330380+
7/32	11,85	8,7	25	10	9216070101	5	9012616
9/32	11,85	10,8	25	11	9216090101	5	9012630
5/16	11,85	11,5	25	11	9216100101	5	9012647
3/8	12	12,85	25	12	9216120101	5	9012654
7/16	14	15,85	25	16	9216140101	5	9012661
1/2	14	16,85	25	18	9216160101	5	9012678
9/16	14	19,7	25	28	9216180101	5	9012685

DOUILLE 6 PANS SÉRIE LONGUE 1/4"

NF ISO 2725 - DIN 3124

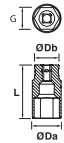

Dim mm	ØDb mm	ØDa mm	L mm	g	Ref.	Ref.	EAN 330380+
4	11,85	6,8	50	16	9220040001	5	9220042
5	11,85	8	50	18	9220050001	5	9220059
6	11,85	9,3	50	18	9220060001	5	9220066
7	11,85	10,8	50	21	9220070001	5	9220073
8	11,85	11,5	50	21	9220080001	5	9220080
9	12	12,85	50	27	9220090001	5	9220097
10	12	14,35	50	33	9220100001	5	9220103
11	14	15,85	50	39	9220110001	5	9220110
12	14	16,85	50	43	9220120001	5	9220127
13	14	17,85	50	43	9220130001	5	9220134
14	14	19,7	50	54	9220140001	5	9220141

RACKS DE DOUILLES LONGUES 1/4" 12 PIÈCES

4 à 14 mm - 6 pans

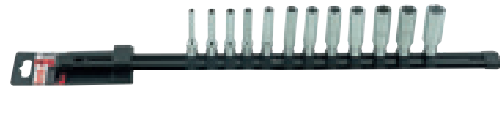

Pans	Contenu	L mm	g	Ref.	Ref.	EAN 330380+
6	4-5-5.5-6-7-8-9-10-11-12-13-14 mm	483	470	9481012101	1	0010963

AUGMENTATEUR CARRÉ 1/4" A 3/8"

1/4" A 3/8"

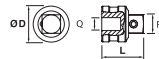

L mm	ØD mm	g	Ref.	Ref.	EAN 330380+
25	12	15	9290380001	1	9290120

CARDAN UNIVERSEL 1/4"

NF ISO 3316 - DIN 3123

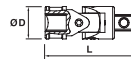

L mm	ØD mm	g	Ref.	Ref.	EAN 330380+
38	14	25	9250000001	1	9250001

CARDAN UNIVERSEL 1/4" SUR CARTE

NF ISO 3316 - DIN 3123



L mm	Ø mm	g	Ref.	Ref.	EAN 330380+
38	14	25	9250001001	1	9250018

RALLONGE CLICK'N HOLD



SÉCURITÉ

- La douille est verrouillée et ne se désolidarise pas de la rallonge.



SIMPLICITÉ

- Le déplacement de la bague déverrouille la douille, le geste est intuitif et simple.



RALLONGE 1/4" CLICK'N HOLD

A bague de verrouillage



L mm	Ø1 mm	Ø2 mm	g	Ref.	Ref.	EAN 330380+
140	12	13	70	9265140001	1	9005410

RALLONGE FLEXIBLE 1/4"



L mm	ØD mm	g	Ref.	Ref.	EAN 330380+
150	12	64	9260000001	1	9260000

RALLONGE 1/4"

NF ISO 3316 - DIN 3123



L mm	ØD mm	g	Ref.	Ref.	EAN 330380+
50	12	24	9260050001	1	9260055
75	12	35	9260070001	1	9260079
125	12	57	9260120001	1	9260123

RALLONGE 1/4" SUR CARTE

NF ISO 3316 - DIN 3123



L mm	Ø mm	g	Ref.	Ref.	EAN 330380+
50	12	24	9260051001	1	9260017
125	12	57	9260121001	1	9260130

POIGNÉE COULISSANTE 1/4"

NF ISO 3315 - DIN 3122



L mm	ØD1 mm	ØD2 mm	H mm	g	Ref.	Ref.	EAN 330380+
115	6,3	13,3	24	50	9270110001	1	9270115

POIGNÉE COULISSANTE 1/4" SUR CARTE

NF ISO 3315 - DIN 3122



L mm	ØD1 mm	ØD2 mm	H mm	g	Ref.	Ref.	EAN 330380+
115	6,3	13,3	24	50	9270111001	1	9270122

POIGNÉE ARTICULÉE MANCHE ACIER 1/4"



L mm	A mm	Ø mm	g	Ref.	Ref.	EAN 330380+
150	13,8	1,14	115	9284150101	1	9007520

- 9
- 69
- 103
- 129
- 133
- 155
- 187
- 197
- 223
- 231
- 257
- 273
- 277
- 283

CLIQUETS ET DOUILLES 1/4"

DOUILLES ET ACCESSOIRES

SPIN POWER



ULTRA-RAPIDE

- En phase de serrage / desserrage rapide : la clé en T tourne extrêmement vite, sans friction. La poignée aluminium rouge reste dans la main pendant que l'axe tourne.

FINITION

- Tige en Chrome Vanadium finition Nickel-Chrome.
- Poignée rotative en aluminium anodisé moleté.
- Bague de déverrouillage pour ajustage en 3 positions.



SPIN POWER 1/4" SUR CARTE

Poignée rotative - 3 positions



L mm	l mm	L1 mm	Ø1 mm	Ø2 mm	g	Ref.	Ref.	Ref.	EAN 330380+
325	142	102	9	19	330	9278141001	1	9011626	

POIGNÉE TOURNEVIS 1/4"



ØDb mm	ØDa mm	L1 mm	L mm	g	Ref.	Ref.	Ref.	EAN 330380+
33	8	51	160	80	9283160001	1	9283160	

DOUILLE PORTE-EMBOUTS 6 PANS 1/4"

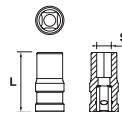

S mm	L mm	g	Ref.	Ref.	Ref.	EAN 330380+
1/4	25	12	929A000101	5	9290113	

DOUILLE PORTE-EMBOUTS 6 PANS 1/4" SUR CARTE

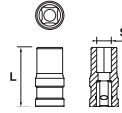

S mm	L mm	g	Ref.	Ref.	Ref.	EAN 330380+
1/4	25	12	929A001101	3	9290298	

DOUILLE TOURNEVIS DE TYPE PHILLIPS 1/4"

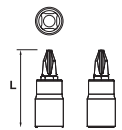

Type	L mm	g	Ref.	Ref.	Ref.	EAN 330380+
PH2	32	10	929B020401	5	9290045	
PH3	32	10	929B030401	5	9002938	

DOUILLE TOURNEVIS DE TYPE POZIDRIV 1/4"

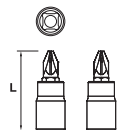

Type mm	L mm	g	Ref.	Ref.	Ref.	EAN 330380+
PZ1	32	10	929C010401	5	9290052	

DOUILLE TOURNEVIS DE TYPE HEXAGONAL 1/4"

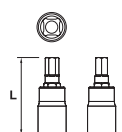

Type mm	L mm	g	Ref.	Ref.	Ref.	EAN 330380+
H3	32	9	929E030401	5	9290076	
H4	32	10	929E040401	5	9290083	
H5	32	10	929E050401	5	9290090	
H6	32	15	929E060401	5	9290106	
H8	32	15	929E080401	5	9002747	

DOUILLE TOURNEVIS DE TYPE TORX 1/4"

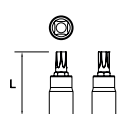

Type mm	L mm	g	Ref.	Ref.	Ref.	EAN 330380+
T10	32	9	929D100401	5	9290304	
T15	32	9	929D150401	5	9290403	
T20	32	10	929D200401	5	9290502	
T25	32	10	929D250401	5	9290601	
T30	32	15	929D300401	5	9003027	

XS BOX

COMPACTITÉ

- Idéal pour les espaces restreints
- Se range dans une caisse à outils
- 1 clé 2 en 1: cliquet et porte-embout à cliquet.

COFFRET 39 PIÈCES

- Coffret complet avec douilles 1/4"
- 30 embouts de vissage d'acier supérieur S2



QUALITÉ DU COFFRET

- Charnière renforcée par une tige métallique.
- Facilité d'extraction des embouts.
- Repérage facilité des outils grâce à la mousse de calage imprimée bicolore : repérage facilité des outils manquants.
- Fermeture à verrouillage latéral. En cas de chute, le coffret ne s'ouvre pas.



Embouts : hauteur 28 mm
(au lieu de 58 mm avec un porte-embout
et un cliquet classique)

Douilles : hauteur 35 mm
(au lieu de 44 mm avec
un cliquet classique)

COFFRET XS BOX 39 PIÈCES 1/4" SUR CARTE

- 1 clé 2 en 1 : cliquet et porte-embout
- 30 embouts de vissage :
 - 5 Fentes : 4/4,5/5,5/6,5/8
 - 6 Pozidriv : PZ0/PZ1x2/PZ2x2/PZ3
 - 4 Phillips : PH0/PH1/PH2/PH3
 - 7 Torx : T10/T15/T20/T25/T27/T30/T40
 - 8 Hexagonaux : H1,5/H2/H2,5/H3/H4/H5/H6/H8
- 1 rallonge 125 mm
- 7 Douilles 1/4" : 4/7/8/10/12/13/14 mm



Nb pièces

39

Dim mm

175x110x40

g

560

Ref.

9410390001

1

EAN 330380+

9010681



9



69



103



129



133



155



187



197



223



231



257



273



277



283

CLIQUETS ET DOUILLES 1/4"

COFFRETS

BOX 31



COMPACTITÉ

- Se range dans une caisse à outils
- 1 clé 2 en 1: cliquet et porte-embout à cliquet.

COFFRET 39 PIÈCES

- Coffret complet avec douilles 1/4" extra-courtes
- 23 embouts de vissage d'acier supérieur S2

QUALITÉ DU COFFRET

- Facilité d'extraction des embouts.
- Repérage facilité des outils grâce à la mousse de calage imprimée bicolore : pour un repérage facilité des outils manquants.
- Fermeture à verrouillage latéral.
- Résistant aux solvants et hydrocarbures

BOX 31 - COFFRET VISSAGE 1/4 - 31 PIÈCES

1 clé 2 en 1 : cliquet et porte-embout -

23 embouts de vissage extra-courts :

- 2 Fentes : 4/5,5 - 5 Pozidriv : PZ0/PZ1/PZ2x2/PZ3
- 5 Phillips : PH0/PH1/PH2x2/PH3
- 7 Torx : T10/T15/T20/T25/T27/T30/T40
- 4 Hexagonaux : H3/H4/H5/H6
- 7 douilles 1/4" extra-courtes : 5/7/8/10/12/13/14 mm



Nb pièces	Dim mm	g	Ref.	Ref.	EAN 330380+
31	125x90x30	285	9460031001	1	9472076

CLIQUET PORTE-DOUILLE / PORTE-EMBOUTS 1/4"



L mm	A1 mm	A2 mm	B1 mm	B2 mm	g	Ref.	Ref.	EAN 330380+
145	13	13	23	21	90	9205000001	1	9205001

COFFRET MÉTALLIQUE 1/4" 29 PIÈCES 6 PANS CLIQUET ROND



- 11 douilles
- 1 cliquet rond
- 1 cardan
- 1 poignée coul.
- 1 rallonge
- 1 poignée +
- 1 douille porte-embouts
- 12 embouts



 9200 : forme poire - bimatière	 9270	 929B : PH1-PH2
 9210 : 4-4,5-5-5,5-6-7-8-9-10-11-13 mm	 929A	 929C : PZ1-PZ2
 9250	 9283	 929E : H3-H4-H5-H6
 9260 : 75 mm	 929A : 4-5,5 mm	 929D : T30-T40

Nb pièces	Dim mm	g	Ref.	Ref.	EAN 330380+
29	240x115x40	985	0000983401	1	0098343

COFFRET PLASTIQUE 1/4" 31 PIÈCES 6 PANS CLIQUET POIRE



- 10 douilles
- 1 cliquet poire
- 1 cardan
- 1 poignée coul.
- 3 rallonges
- 1 poignée embouts
- 14 douilles tournevis



 9200 : forme poire - bimatière	 9260 : 75-125 mm	 929B : PH1-PH2
 9210 : 4-5-6-7-8-9-10-11-12-13 mm	 9260 : flexible - 150 mm	 929E : H3-H4-H5-H6
 9250	 9270	 929D : T10-T15-T20-T25-T30-T45
 9283	 929A : 4-5,5 mm	

Nb pièces	Dim mm	g	Ref.	Ref.	EAN 330380+
31	260x175x60	1115	9410310101	1	9410047

COFFRETS 1/4" 16 PIÈCES THERMOFORMÉS

COFFRETS 16 PIÈCES

- Coffret PEHD avec fond thermoformé

COMPOSITION

- Cliquet Premium avec bouton d'éjection, 72 dents (angle de reprise 5°), au choix rond ou poire
- Douilles avec épaulement, au choix 6 ou 12 pans
- 2 rallonges
- 1 cardan

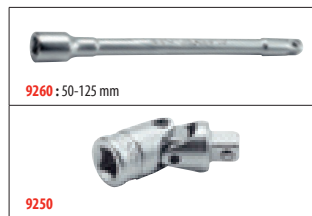

COFFRET BOX 1/4" 16 PIÈCES 6 PANS CLIQUET POIRE

- 12 douilles 6 pans
- 1 cliquet poire
- 1 cardan
- 2 rallonges

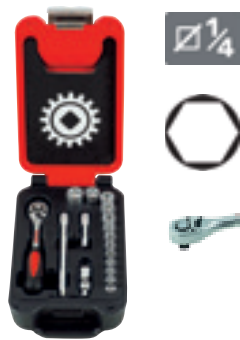

Nb pièces	Dim mm	g	Ref.	Ref.	EAN 330380+
16	135x215x60	740	9415016001	1	9002440

COFFRET BOX 1/4" 16 PIÈCES 6 PANS CLIQUET ROND

- 12 douilles 6 pans
- 1 cliquet Premium rond
- 1 cardan
- 2 rallonges



Nb pièces	Dim mm	g	Ref.	Ref.	EAN 330380+
16	135x215x60	1200	9415016201	1	9002426

COFFRET BOX 1/4" 16 PIÈCES 12 PANS CLIQUET POIRE

- 12 douilles 12 pans
- 1 cliquet poire
- 1 cardan
- 2 rallonges



Nb pièces	Dim mm	g	Ref.	Ref.	EAN 330380+
16	135x215x60	1000	9415016101	1	9003119

COFFRET BOX 1/4" 16 PIÈCES 12 PANS CLIQUET ROND

- 12 douilles 12 pans
- 1 cliquet Premium rond
- 1 cardan
- 2 rallonges



Nb pièces	Dim mm	g	Ref.	Ref.	EAN 330380+
16	135x215x60	1000	9415016301	1	9002433



9



69



103



129



133



155



187



197



223



231



257



273



277



283

CLIQUETS ET DOUILLES 1/4"

COFFRETS

COFFRET 1/4" 46 PIÈCES



CONTENU

- Coffret complet 1/4" et vissage : cliquet Premium, 10 douilles, une poignée tournevis, 30 embouts de vissage, rallonges dont une flexible exclusive.
- Existe en 2 versions de cliquet :
 - Cliquet Fast à bague rotative, très pratique pour les débuts de vissage
 - Cliquet rond Premium à changement de sens sur le dessus de la tête



COFFRET

- Polyéthylène Haute Densité (PEHD), ne s'abîme pas aux chocs comme des coffrets métalliques, qu'il est nécessaire de débosser.
- Fermoirs métalliques.
- Mousse HD bicolore pour un repérage facile des manquants.



Disponible avec cliquet Fast



COFFRET BOX 1/4" 46 PIÈCES 6 PANS CLIQUET FAST

- 10 douilles 6 pans : 5,5/6/7/8/9/10/11/12/13/14mm
- Cliquet Premium FAST à couronne rotative, 72 dents angle de reprise de 5°, bouton d'éjection de la douille, changement de sens sur la circonférence de la tête, manche bimatière.
- 1 cardan
- 1 rallonge : 150 mm flexible
- 1 rallonge : 50 mm
- 1 poignée tournevis
- 1 douille porte-embouts
- 30 embouts variés : 5 Fentes : 4/4,5/5,5/6,5/8 mm / 4 Phillips : PH0/PH1/PH2/PH3 / 6 Pozidriv : PZ0/2xPZ1/2xPZ2/PZ3 / 7 Torx : T10/T15/T20/T25/T27/T30/T40 / 8 Hexagonaux : H1,5/H2/H2,5/H3/H4/H5/H6/H8.



COFFRET BOX 1/4" 46 PIÈCES 6 PANS CLIQUET ROND

- 10 douilles 6 pans : 5,5/6/7/8/9/10/11/12/13/14mm
- 1 cliquet Premium rond
- 1 cardan
- 1 rallonge : 150 mm flexible
- 1 rallonge : 50 mm
- 1 poignée tournevis
- 1 douille porte-embouts
- 30 embouts variés : 5 Fentes : 4/4,5/5,5/6,5/8 mm / 4 Phillips : PH0/PH1/PH2/PH3 / 6 Pozidriv : PZ0/2xPZ1/2xPZ2/PZ3 / 7 Torx : T10/T15/T20/T25/T27/T30/T40 / 8 Hexagonaux : H1,5/H2/H2,5/H3/H4/H5/H6/H8.



Nb pièces	Dim mm	g	Ref.	EAN
46	135x215x60	990	9416046201	330380+ 9420046

Nb pièces	Dim mm	g	Ref.	EAN
46	135x215x60	990	9416046001	330380+ 9011688

COFFRET AVEC CLIQUET TÊTE ROTATIVE



TÊTE ROTATIVE LIBREMENT ORIENTABLE

- Utilisable comme un tournevis classique en position 0°.
- Utile lorsque la situation nécessite un dégagement.
- Utilisable en cliquet classique à 90°.
- Cliquet de 100 dents.
- Angle de rotation de 3,6°.
- Verrouillage et déverrouillage rapides des douilles par bouton poussoir.

ERGONOMIE

- Le changement du sens de serrage se réalise facilement avec le pouce sur toute la circonférence de la tête.
- Manche bimatériau
- Coffret PEFD calage mousse bicolore haute-densité.
- Fermeture métal.

CONTENU DU COFFRET

- 12 douilles 6 pans 4 à 14 mm
- 1 cliquet rond tête rotative
- 2 rallonges : 50-125 mm
- 1 douille porte-embouts
- 30 embouts de vissage



COFFRET BOX 1/4" 46 PIÈCES 6 PANS CLIQUET TÊTE ROTATIVE

- 12 douilles 6 pans : 4/5/5,5/6/7/8/9/10/11/12/13/14 mm
- 1 cliquet rond tête rotative
- 2 rallonges : 50-125 mm
- 1 douille porte-embouts
- 30 embouts de vissage : 4 fentes : 3/4,5/5,5/8 // 5 Phillips : PH1/PH2x2/PH3x2 // 5 Pozidriv : PZ1/PZ2x2/PZ3x2 // 10 Torx : T7/T8/T9/T10/T15/T20/T25/T27/T30/T40 // 6 Hexagonaux : H3/H4/H5/H6/H8/H10.

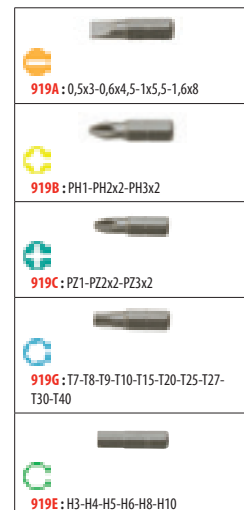

Nb pièces	Dim mm	g	Ref.		EAN 330380+
46	135x215x60	900	9416046101	1	9009661



9



69



103



129



133



155



187



197



223



231



257



273



277



283

CLIQUETS ET DOUILLES 3/8"

CLIQUETS

CLIQUET CARRÉ 3/8"

CLIQUET

- Verrouillage et déverrouillage rapides des douilles par bouton poussoir.



ACCESSIBILITÉ

- L'angle de rotation de 5° (cliquet à 72 dents) assure une reprise très performante dans des espaces réduits.
- Les têtes des cliquets ont un encombrement réduit pour offrir l'accessibilité maximale.

MANCHE CONFORTABLE BIMATIÈRE

Étudié pour travailler dans toutes les positions.

- Le polypropylène pour plus de résistance.
- L'élastomère pour une bonne prise en main.

LIAISON CORPS-MANCHE DU CLIQUET

- Étudiée pour ne pas gêner la main lors de la prise.

ERGONOMIE

- Le changement du sens de serrage se réalise facilement avec le pouce sur toute la circonférence de la tête.
- Prise pleine main
- Forme de manche favorisant naturellement le placement des doigts et assurant une bonne prise nécessaire aux serrages puissants.
- Évasement anti-glissement de la main.



CLIQUET MEDIUM 3/8"



L mm	ØD mm	H mm	g	Ref.	Ref.	EAN 330380+
192	31	34	218	9201720001	1	9201720

KIT RÉPARATION CLIQUET FAST 3/8"

Pièces permettant la réparation du cliquet.

Ref.	EAN 330380+
92017200K1	9202017

DOUILLE 6 PANS 3/8"

NF ISO 2725 - DIN 3124

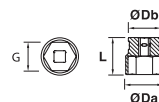

Dim mm	ØDb mm	ØDa mm	L mm	g	Ref.	Ref.	EAN 330380+
7	16,9	10,7	30	24	9211070001	5	9211071
8	16,9	11,9	30	24	9211080001	5	9211088
9	16,9	13,2	30	25	9211090001	5	9211095
10	16,9	14,4	30	25	9211100001	5	9211101
11	16,9	15,7	30	25	9211110001	5	9211118
12	16,9	16,4	30	27	9211120001	5	9211125
13	17	17,8	30	28	9211130001	5	9211132
14	17,5	19,7	30	37	9211140001	5	9211149
15	18	21	30	42	9211150001	5	9211156
16	18	21,8	30	47	9211160001	5	9211163
17	19	23,8	30	57	9211170001	5	9211170
18	20	24,6	30	61	9211180001	5	9211187
19	20	25,7	30	62	9211190001	5	9211194
20	20	27,2	30	75	9211200001	5	9211200
21	22	28	30	78	9211210001	5	9211217
22	22	29,7	30	92	9211220001	5	9211224
23	22	31	30	93	9211230001	5	9211231
24	22	31,9	30	109	9211240001	5	9211248

CLIQUETS ET DOUILLES 3/8"

DOUILLES, ACCESSOIRES, COFFRETS

DOUILLE 12 PANS 3/8"

NF ISO 2725 - DIN 3124

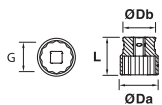

Dim mm	ØDb mm	ØDa mm	L mm	g	Ref.	Ref.	EAN 330380+
13	17	17,8	30	28	9217130001	5	9217134
17	19	23,8	30	57	9217170001	5	9217172

DOUILLE 12 PANS SÉRIE LONGUE 3/8"

NF ISO 2725 - DIN 3124

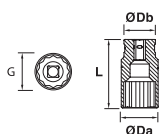

Dim mm	ØDb mm	ØDa mm	L mm	g	Ref.	Ref.	EAN 330380+
7	16,9	10,7	63	48	9226070001	5	9226075
8	16,9	11,9	63	49	9226080001	5	9226082
9	16,9	13,2	63	52	9226090001	5	9226099
10	16,9	14,4	63	52	9226100001	5	9226105
11	16,9	15,7	63	60	9226110001	5	9226112
12	16,9	16,4	63	73	9226120001	5	9226129
13	17	17,8	63	74	9226130001	5	9226136
15	18	21	63	84	9226150001	5	9226150
16	18	21,8	63	97	9226160001	5	9226167
17	19	23,8	63	123	9226170001	5	9226174
18	20	24,6	63	124	9226180001	5	9226181
19	20	25,7	63	138	9226190001	5	9226198
20	20	27,2	63	157	9226200001	5	9226204
21	22	28	63	164	9226210001	5	9226211
22	22	29,7	63	188	9226220001	5	9226228
24	22	31,9	63	210	9226240001	5	9226242

DOUILLE PORTE-EMBOUS 6 PANS 3/8"

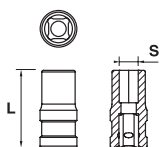

S mm	L mm	g	Ref.	Ref.	EAN 330380+
3/8	25	30	929A000201	5	9290281

CARDAN UNIVERSEL 3/8"

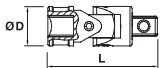

L mm	ØD mm	g	Ref.	Ref.	EAN 330380+
50	18	60	9251000001	1	9251015

RÉDUCTEUR CARRÉ 3/8" A 1/4"

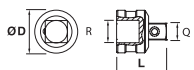

L mm	ØD mm	g	Ref.	Ref.	EAN 330380+
30	18	27	9291140001	1	9290144

AUGMENTATEUR CARRÉ 3/8" A 1/2"

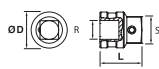

L mm	ØD mm	g	Ref.	Ref.	EAN 330380+
30	18	42	9291120001	1	9290151

RALLONGE 3/8"

NF ISO 3316 - DIN 3123

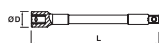

L mm	ØD mm	g	Ref.	Ref.	EAN 330380+
75	18	80	9261070001	1	9261076
125	18	115	9261120001	1	9261120
250	18	205	9261250001	1	9261052

POIGNÉE ARTICULÉE 3/8"

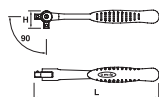

L mm	H mm	g	Ref.	Ref.	EAN 330380+
250	28	330	9285250101	1	9007537

COFFRET BOX 3/8" 23 PIÈCES CLIQUET ROND

- 18 douilles : 7-8-9-10-11-12-13-14-15-16-17-18-19-20-21-22-23-24 mm
- 1 cliquet
- 1 cardan
- 1 poignée coulissante
- 2 rallonges de 125 et 250 mm



Pans	g	Ref.	Ref.	EAN 330380+
6	3200	9420010001	1	9420015



69



103



129



133



155



187



197



223



231



257



273



277



283

CLIQUETS ET DOUILLES 1/2"

CLIQUETS

CLIQUET ROND MOB 1/2"



SÉCURITÉ DU TRAVAIL

Verrouillage et déverrouillage rapides par bouton poussoir.

ACCESSIBILITÉ

- L'angle de rotation de 5° (cliquet à 72 dents) assure une reprise très performante dans des espaces réduits.
- Les têtes des cliquets ont un encombrement réduit pour offrir l'accessibilité maximale.

LIAISON CORPS-MANCHE DU CLIQUET

- Étudiée pour ne pas gêner la main lors de la prise.

ERGONOMIE

Étudié pour travailler dans toutes les positions.

- Le polypropylène pour plus de résistance.
- L'élastomère pour une bonne prise en main.
- Le changement du sens de serrage se réalise facilement avec le pouce sur toute la circonférence de la tête.
- Prise pleine main
- Forme de manche favorisant naturellement le placement des doigts et assurant une bonne prise nécessaire aux serrages puissants.
- Évasement anti-glissement de la main.
- Réparable



Liaison corps-manche du cliquet étudiée pour ne pas gêner la main lors de la prise.



Saisie en extrémité du manche grâce à sa forme sphérique.

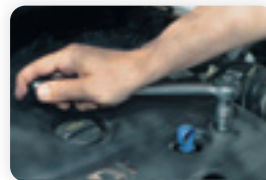

Prise inversée facilitée.

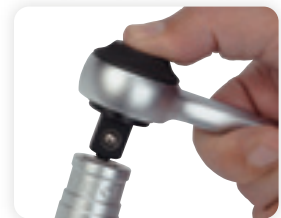
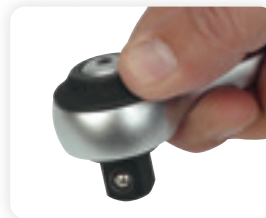

CLIQUET ROND 1/2"

72 dents. Bouton d'éjection.



L mm	ØD mm	H mm	g	Ref.	Ref.	EAN 330380+
243	38	45	490	9202720001	1	9202727

CLIQUET ROND 1/2" SUR CARTE



L mm	ØD mm	H mm	g	Ref.	Ref.	EAN 330380+
243	38	45	490	9202721001	1	9202000



KIT RÉPARATION CLIQUET ROND 1/2"

Pièces permettant la réparation du cliquet.

Repair

NE JETEZ PLUS, RÉPAREZ !

Prolonger la durée d'usage en réparant permet de réduire notre empreinte environnementale tout en diminuant la quantité de déchets produits. C'est ainsi une belle manière d'œuvrer pour le futur.



g	Ref.	EAN 330380+
100	92027200K1	9205056

CLIQUET FAST



MOLETTE INTÉGRÉE

- Gain de temps : l'approche se fait à la main avec le cliquet.
- Maîtrise : la vis s'engage facilement.
- Fiabilité : molette monobloc, usinée une pièce avec le carré. Ajoute 5 mm seulement à la hauteur du cliquet.
- Système breveté. Développé en France par notre BE.
- Cliquet 72 dents : angle de reprise de 5° pour des espaces réduits.

ERGONOMIE

- Manche confortable bimatière :
 - polypropylène pour plus de résistance,
 - élastomère pour une bonne prise en main.
- Étudié pour travailler dans toutes les positions : liaison corps-manche du cliquet, pour ne pas gêner la main lors de la prise. Forme en bout pour une saisie en extrémité facilitée et une bonne tenue dans la paume.

PRATIQUE

- Changement de sens par rotation sur toute la circonférence de la tête.

SÉCURITÉ DU TRAVAIL

- Verrouillage et déverrouillage rapides des douilles par bouton poussoir d'éjection.
- Réparable



CLIQUET FAST 1/2" - SUR CARTE

Molette intégrée. 72 dents. Bouton d'éjection.



L mm	ØD mm	H mm	g	Ref.	Ref.	EAN 330380+
243	38	50	495	9202721301	1	9205032

Repair

NE JETEZ PLUS, RÉPAREZ !

Prolonger la durée d'usage en réparant permet de réduire notre empreinte environnementale tout en diminuant la quantité de déchets produits. C'est ainsi une belle manière d'œuvrer pour le futur.

KIT RÉPARATION CLIQUET FAST 1/2"

Pièces permettant la réparation du cliquet.

g	Ref.	EAN 330380+
112	92027203K1	9205063



9



69



103



129



133



155



187



197



223



231



257



273



277



283

CLIQUETS ET DOUILLES 1/2"

CLIQUETS

CLIQUET TÊTE ROTATIVE 1/2"

TÊTE ROTATIVE LIBREMENT ORIENTABLE

- Utilisable comme un tournevis classique en position 0°
- Utile lorsque la situation nécessite un dégagement
- Utilisable en cliquet classique à 90°.

PERFORMANCE

- 100 dents.
- Accessibilité : angle de reprise de 3,6° pour des espaces réduits.



CLIQUET ROND TÊTE ROTATIVE 1/2"

100 dents. Bouton d'éjection.



L mm	ØD mm	H mm	g	Ref.	Ref.	EAN 330380+
293	38	43	670	9202100001	1	9205025

CLIQUET POIRE 1/2"

CLIQUET À LEVIER

- Levier de changement de sens intégré dans la tête = pas de risque d'inversion accidentelle.
- Déverrouillage des douilles par bouton poussoir.

ERGONOMIE

- Changement de sens par le pouce.

VISIBILITÉ

- Le sens est donné par la position du levier, pas besoin de tester le sens de rotation.



CLIQUET POIRE 1/2"

72 dents. Bouton d'éjection.
A levier de changement de sens.



CLIQUET POIRE 1/2" SUR CARTE



L mm	D mm	H mm	g	Ref.	Ref.	EAN 330380+
263	40	20,5	595	9202720101	1	9202734

L mm	ØD mm	H mm	g	Ref.	Ref.	EAN 330380+
263	40	20,5	595	9202721101	1	9010216

DOUILLES 1/2"

ERGONOMIE

- La manipulation des douilles est rendue facile grâce à un épaulement extérieur prévu pour la prise.
- Pour trouver rapidement la douille souhaitée sa dimension est marquée sur tout le pourtour.

RÉSISTANCE

- La suppression des angles vifs des carrés augmente leur résistance.

6 PANS - 2 PANS

2 gammes de douilles :

- 6 pans pour serrages puissants.
- 12 pans pour la mise en place et la reprise facile dans les endroits encombrés.



Epaulement extérieur pour une meilleure prise



Résistance : la suppression des angles vifs des carrés augmente leur résistance.



DOUILLE 6 PANS 1/2"

NF ISO 2725 - DIN 3124

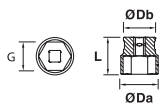

DOUILLE 6 PANS 1/2" SUR CARTE

NF ISO 2725 - DIN 3124

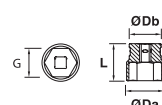

Dim mm	ØDb mm	ØDa mm	L mm	g	Ref.	Ref.	EAN 330380+
8	22	12,8	38	44	9212080001	5	9112088
9	22	14,2	38	45	9212090001	5	9112095
10	22	15,3	38	49	9212100001	5	9112101
11	22	16,5	38	50	9212110001	5	9112118
12	22	17,8	38	51	9212120001	5	9112125
13	22	19	38	53	9212130001	5	9112132
14	22	20,3	38	55	9212140001	5	9112149
15	22	21,5	38	58	9212150001	5	9112156
16	22	23	38	62	9212160001	5	9112163
17	22	24	38	64	9212170001	5	9112170
18	22	25,3	38	68	9212180001	5	9112187
19	24	26,5	38	68	9212190001	5	9112194
20	24	28	38	78	9212200001	5	9112200
21	25	29	38	85	9212210001	5	9112217
22	25	30	40	90	9212220001	5	9112224
23	26	31	40	94	9212230001	5	9112231
24	26	33	40	102	9212240001	5	9112248
25	26	34	42	102	9212250001	5	9112255
26	28	35	45	110	9212260001	5	9112262
27	28	36	45	110	9212270001	5	9112279
28	28	38	45	112	9212280001	5	9112286
29	28	39	45	112	9212290001	5	9112293
30	28	40	45	116	9212300001	5	9112309
32	28	42	45	116	9212320001	5	9112323

Dim mm	L mm	g	Ref.	Ref.	EAN 330380+
8	38	44	9212081001	3	9212818
10	38	49	9212101001	3	9212849
11	38	50	9212111001	3	9212856
12	38	51	9212121001	3	9212863
13	38	53	9212131001	3	9212870
14	38	55	9212141001	3	9212887
15	38	58	9212151001	3	9212894
16	38	62	9212161001	3	9212900
17	38	64	9212171001	3	9212917
18	38	68	9212181001	3	9212924
19	38	68	9212191001	3	9212931
20	38	78	9212201001	3	9212948
21	38	85	9212211001	3	9212955
22	40	90	9212221001	3	9212023
23	40	94	9212231001	3	9212962
24	40	102	9212241001	3	9212979
26	45	110	9212261001	3	9212986
27	45	110	9212271001	3	9212993
30	45	116	9212301001	3	9212009
32	45	116	9212321001	3	9212016



9



69



103



129



133



155



187



197



223



231



257



273



277



283

CLIQUETS ET DOUILLES 1/2"

DOUILLES ET ACCESSOIRES

RACKS DE DOUILLES 1/2" 14 PIÈCES 6 PANS

8 à 24 mm



Contenu	L mm	g	Ref.	Ref.	EAN 330380+
8-10-11-12-13-14-15-16-17-18-19-21-22-24 mm	483	1200	9482014001	1	0010970

DOUILLE 6 PANS 1/2"

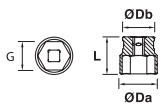

Dim. pouces	ØDb mm	ØDa mm	L mm	g	Ref.	Ref.	EAN 330380+
1/2	22	19	38	53	9212160101	5	9013569
9/16	22	20,3	38	55	9212180101	5	9013576

DOUILLE 12 PANS 1/2"

NF ISO 2725 - DIN 3124



Dim mm	ØDb mm	ØDa mm	L mm	g	Ref.	Ref.	EAN 330380+
8	22	12,8	38	44	9215080001	5	9215086
9	22	14,2	38	45	9215090001	5	9215093
10	22	15,3	38	49	9215100001	5	9215109
11	22	16,5	38	50	9215110001	5	9215116
12	22	17,8	38	51	9215120001	5	9215123
13	22	19	38	53	9215130001	5	9215130
14	22	20,3	38	55	9215140001	5	9215147
15	22	21,5	38	58	9215150001	5	9215154
16	22	23	38	62	9215160001	5	9215161
17	22	24	38	64	9215170001	5	9215178
18	22	25,3	38	68	9215180001	5	9215185
19	24	26,5	38	68	9215190001	5	9215192
20	24	28	38	78	9215200001	5	9215208
21	25	29	38	85	9215210001	5	9215215
22	25	30	40	90	9215220001	5	9215222
23	26	31	40	94	9215230001	5	9215239
24	26	33	40	102	9215240001	5	9215246
25	26	34	42	102	9215250001	5	9215253
26	28	35	45	110	9215260001	5	9215260
27	28	36	45	110	9215270001	5	9215277
28	28	38	45	112	9215280001	5	9215284
30	28	40	45	116	9215300001	5	9215307
32	28	42	45	116	9215320001	5	9215321

DOUILLE 12 PANS 1/2" SUR CARTE

NF ISO 2725 - DIN 3124



Dim mm	L mm	g	Ref.	Ref.	EAN 330380+
10	38	49	9215101001	3	9215833
13	38	53	9215131001	3	9215864
17	38	64	9215171001	3	9215918
18	38	68	9215181001	3	9215925
19	38	68	9215191001	3	9215932
21	38	85	9215211001	3	9215956
24	40	102	9215241001	3	9215987
30	45	116	9215301001	3	9215048

DOUILLE 12 PANS SÉRIE LONGUE 1/2"

NF ISO 2725 - DIN 3124

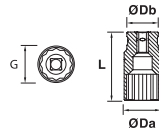

Dim mm	ØDb mm	ØDa mm	L mm	g	Ref.	Ref.	EAN 330380+
12	22	17,8	78	128	9227120001	5	9227126
13	22	19	78	130	9227130001	5	9227133
14	22	20,3	78	132	9227140001	5	9227140
15	22	21,5	78	132	9227150001	5	9227157
16	22	23	78	140	9227160001	5	9227164
17	22	24	78	150	9227170001	5	9227171
18	22	25,3	78	160	9227180001	5	9227188
19	24	26,5	78	160	9227190001	5	9227195
20	24	28	78	175	9227200001	5	9227201
21	25	29	78	180	9227210001	5	9227218
22	25	30	78	180	9227220001	5	9227225
23	26	31	78	190	9227230001	5	9227232
24	26	33	78	195	9227240001	5	9227249
25	26	34	78	195	9227250001	5	9227256
26	28	35	78	195	9227260001	5	9227263
27	28	36	78	200	9227270001	5	9227270
28	28	38	78	200	9227280001	5	9227287
29	28	39	78	200	9227290001	5	9227294
30	28	40	78	205	9227300001	5	9227300
32	28	42	78	205	9227320001	5	9227324

RACK DE DOUILLES LONGUES 1/2" 14 PIÈCES 12 PANS

12 à 27 mm



Contenu	L mm	g	Ref.	Ref.	EAN 330380+
12-13-14-15-16-17-18-19-20-21-22-23-24-27 mm	445	2200	9430070001	1	9430076

DOUILLE À BOUGIES 6 PANS 1/2"

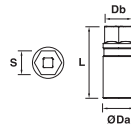

S mm	L mm	ØDb mm	ØDa mm	g	Ref.	Ref.	EAN 330380+
16	67	19	22	110	9281160001	1	9281166
21	67	24	28	160	9281210001	1	9281210

DOUILLE À BOUGIES 6 PANS 1/2" SUR CARTE

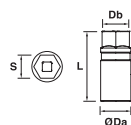

S mm	L mm	ØDb mm	ØDa mm	g	Ref.	Ref.	EAN 330380+
16	67	19	22	110	9281161001	1	9281173

SPIN POWER

ULTRA-RAPIDE

- En phase de serrage/desserrage rapide : la clé en T tourne extrêmement vite, sans friction.
- La poignée aluminium rouge reste dans la main pendant que l'axe tourne.

ULTRA-PUISSANTE

- En phase finale de serrage, la poignée permet de serrer avec puissance, à une ou même 2 mains.

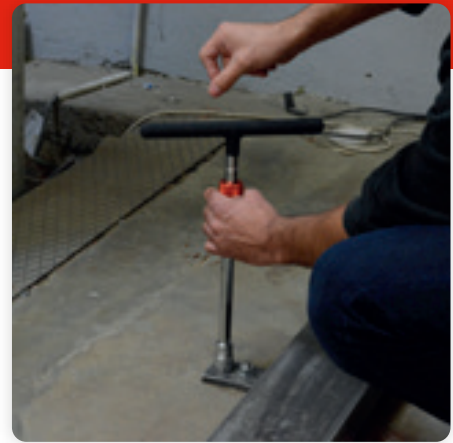

SPIN POWER 1/2" SUR CARTE



L mm	l mm	L1 mm	Ø1 mm	Ø2 mm	Ø3 mm	g	Ref.	Ref.	EAN 330380+
330	243	102	16	31	12	1080	9278121001	1	9011633

RALLONGE CLICK'N HOLD

SÉCURITÉ

- Verrouillage et déverrouillage rapides des douilles par bague-poussoir.
- Les douilles ou les accessoires ne se désolidarisent pas de la rallonge.

SIMPLICITÉ

- Le déplacement de la bague déverrouille la douille, le geste est intuitif.

CARACTÉRISTIQUES

- Montée avec un plongeur « lock pin » : permet de solidariser la douille de l'élément (douille, cliquet).
- Rayon de protection du carré : permet de répartir la charge et évite que la douille se casse. 100% forgé tourné.
- Fabrication en acier chrome-vanadium, le meilleur matériau pour la fabrication de douilles et accessoires.
- Duretés : de 40 à 46 Hrc. Rapport dureté/longévité optimum.



RALLONGE 1/2" CLICK'N HOLD

A bague de verrouillage



L mm	Ø1 mm	g	Ref.	Ref.	EAN 330380+
280	24	505	9267250001	1	9011794

RALLONGE 1/2"

NF ISO 3316 - DIN 3123

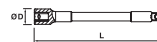

L mm	ØD mm	g	Ref.	Ref.	EAN 330380+
125	24	225	9262120001	1	9262127
250	24	435	9262250001	1	9262257



9



69



103



129



133



155



187



197



223



231



257



273



277



283

CLIQUETS ET DOUILLES 1/2"

DOUILLES ET ACCESSOIRES

RALLONGE 1/2" SUR CARTE

NF ISO 3316 - DIN 3123



L mm	Ø mm	g	Ref.	Ref.	EAN 330380+
125	24	225	9262121001	1	9262134
250	24	435	9262251001	1	9262264

POIGNÉE COULISSANTE 1/2"

NF ISO 3315 - DIN 3122

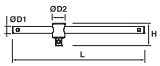

L mm	ØD1 mm	ØD2 mm	H mm	g	Ref.	Ref.	EAN 330380+
255	13,5	24	45	369	9272250001	1	9272256

POIGNÉE COULISSANTE 1/2" SUR CARTE

NF ISO 3315 - DIN 3122

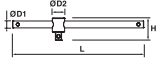

L mm	ØD1 mm	ØD2 mm	H mm	g	Ref.	Ref.	EAN 330380+
255	13,5	24	45	369	9272251001	1	9272263

RÉDUCTEUR CARRÉ 1/2" À 3/8"

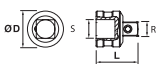

L mm	ØD mm	g	Ref.	Ref.	EAN 330380+
25	24	47	9292380001	1	9290137

CARDAN UNIVERSEL 1/2"

NF ISO 3316 - DIN 3123

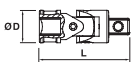

L mm	ØD mm	g	Ref.	Ref.	EAN 330380+
70	25	139	9252000001	1	9252005

CARDAN UNIVERSEL 1/2" SUR CARTE

NF ISO 3316 - DIN 3123

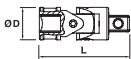

L mm	ØD mm	g	Ref.	Ref.	EAN 330380+
70	25	139	9252001001	1	9252012

DOUILLE TOURNEVIS À FENTE 1/2"

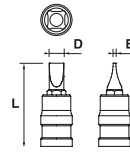

ExD	L mm	g	Ref.	Ref.	EAN 330380+
1,6x10	55	65	929A160201	5	9002884
2,0x12	55	75	929A200201	5	9002891
2,5x16	55	110	929A260201	5	9002921

DOUILLE TOURNEVIS DE TYPE HEXAGONAL 1/2"

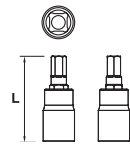

L mm	g	Ref.	Ref.	EAN 330380+	
H5	55	65	929E050201	5	9002754
H6	55	65	929E060201	5	9002761
H7	55	70	929E070201	5	9002778
H8	55	70	929E080201	5	9002785
H9	55	85	929E090201	5	9002792
H10	55	85	929E100201	5	9002808
H12	55	130	929E120201	5	9002822
H14	55	130	929E140201	5	9002839
H17	55	130	929E170201	5	9002846
H19	55	130	929E190201	5	9002853

DOUILLE TOURNEVIS DE TYPE TORX 1/2"

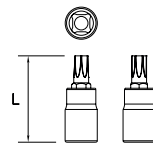

L mm	g	Ref.	Ref.	EAN 330380+	
T27	55	65	929D270201	5	9292308
T30	55	65	929D300201	5	9292407
T40	55	65	929D400201	5	9003041
T45	55	70	929D450201	5	9003058
T50	55	75	929D500201	5	9003065
T55	55	110	929D550201	5	9003072
T60	55	110	929D600201	5	9003096

RACK DE DOUILLES TOURNEVIS HEXA 1/2" 8 PIÈCES

6 à 19 mm



Contenu	L mm	g	Ref.	Ref.	EAN 330380+
H6-H7-H8-H10-H12-H14-H17-H19	183	1050	9482008001	1	0014039

CLIQUETS ET DOUILLES 1/2"

COFFRETS THERMOFORMÉS

COFFRET BOX 1/2" 21 PIÈCES, 6 PANS, CLIQUET POIRE, THERMO

- 17 douilles 6 pans
- 1 cliquet poire 72 dents à bouton d'éjection
- 1 cardan
- 2 rallonges

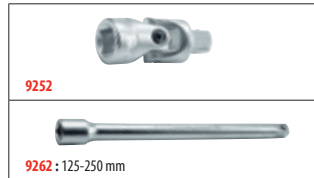
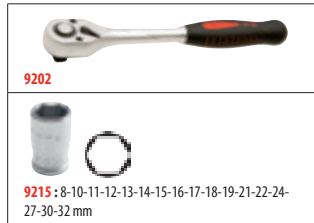

L mm	Dim mm	Ref.	📦	EAN 330380+
21 pcs	405x225x60	9435021001	1	9002358

COFFRET BOX 1/2" 21 PIÈCES, 6 PANS, CLIQUET ROND, THERMO

- 17 douilles 6 pans
- 1 cliquet rond 72 dents à bouton d'éjection
- 1 cardan
- 2 rallonges

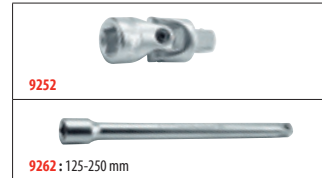
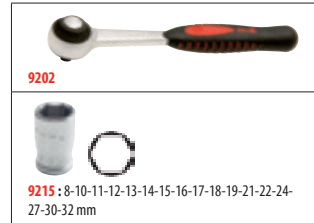

Nb pièces	Dim mm	🏋️ g	Ref.	📦	EAN 330380+
21	405x225x60	3470	9435021201	1	9000477

COFFRET BOX 1/2" 21 PIÈCES, 12 PANS, CLIQUET POIRE, THERMO

- 17 douilles 12 pans
- 1 cliquet poire 72 dents à bouton d'éjection
- 1 cardan
- 2 rallonges

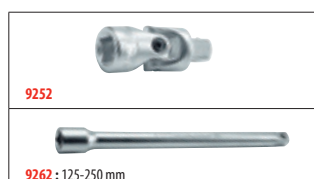
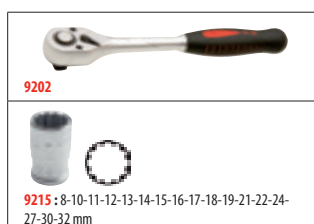

Nb pièces	Dim mm	🏋️ g	Ref.	📦	EAN 330380+
21	405x225x60	3720	9435021101	1	9002402

COFFRET BOX 1/2" 21 PIÈCES, 12 PANS, CLIQUET ROND, THERMO

- 17 douilles 12 pans
- 1 cliquet rond 72 dents à bouton d'éjection
- 1 cardan
- 2 rallonges

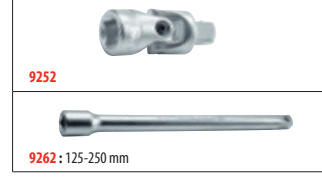
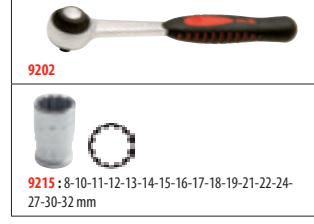

Nb pièces	Dim mm	🏋️ g	Ref.	📦	EAN 330380+
21	405x225x60	3580	9435021301	1	9000484

	9
	69
	103
	129
	133
	155
	187
	197
	223
	231
	257
	273
	277
	283

CLIQUETS ET DOUILLES 1/2"

COFFRETS MOUSSE

COFFRET AVEC CLIQUET TÊTE ROTATIVE



CONCEPTION DU CLIQUET ROTATIF DANS L'AXE

- Articulation dans l'axe de la tête
- Plus compact à l'insertion qu'une articulation déportée

LIBREMENT ORIENTABLE

- Utilisable en rotation dans l'axe, comme un tournevis classique en position 0°
- Utile lorsque la situation nécessite un dégagement
- L'angle de rotation est freiné, ce qui évite de riper.
- Vis latérale de réglage.
- Performance : 100 dents (3,6° pour des espaces réduits).



COFFRET BOX 1/2" 22 PIÈCES, 6 PANS, CLIQUET ROND ROTATIF, MOUSSE

- 17 douilles 6 pans : 8-10-11-12-13-14-15-16-17-18-19-21-22-24-27-30-32 mm
- 1 cliquet rond à tête rotative 100 dents
- 1 cardan
- 1 poignée coulissante
- 2 rallonges 125 et 250 mm.



COFFRET MÉTAL

COFFRET MÉTALLIQUE 1/2" 25 PIÈCES 6 PANS CLIQUET ROND

- 20 douilles 6 pans : 8-9-10-11-12-13-14-15-16-17-18-19-20-21-22-23-24-27-30-32 mm
- 1 cliquet rond 72 dents à bouton d'éjection de douilles
- 1 cardan
- 2 rallonges 125-250 mm
- 1 poignée coulissante



Nb pièces	Dim mm	g	Ref.	EAN
22	405x225x60	4110	9436022001	330380+ 9460059

Nb pièces	Dim mm	g	Ref.	EAN
25	450x180x50	4700	0000998001	330380+ 9980014

COFFRET BOX 1/2" 28 PIÈCES



COFFRET 28 PIÈCES

- 21 douilles, un cliquet Premium 72 dents pour un serrage ultra-rapide,
- 1 poignée coulissante pour le serrage en force,
- 2 rallonges dont une click'n hold exclusive.

AMÉNAGEMENTS INTÉRIEURS

- Mousse bicolore pour un repérage facile des manquants.
- Mousse haute densité, à cellule fermée, qui ne prend pas l'humidité.
- Les outils sont calés en douceur.

QUALITÉ

- Coffret en PEHD Polyéthylène haute Densité, léger et résistant.
- Fermoirs métalliques très résistants.



COFFRET BOX 1/2" 28 PIÈCES, 6 PANS, CLIQUET ROND, MOUSSE

- 21 douilles 6 pans : 8-9-10-11-12-13-14-15-16-17-18-19-20-21-22-23-24-27-28-30-32 mm
- 1 cliquet rond 72 dents à bouton d'éjection de douille
- 1 cardan
- 1 poignée coulissante
- 1 rallonge 125mm // 1 rallonge Click'hold 280mm
- 2 douilles bougies 16 et 21 mm



COFFRET FAST 1/2" 28 PIÈCES, 6 PANS, CLIQUET ROND FAST, MOUSSE

- 21 douilles 6 pans : 8-9-10-11-12-13-14-15-16-17-18-19-20-21-22-23-24-27-28-30-32 mm
- 1 Cliquet Fast molette intégrée 72 dents à bouton d'éjection de douilles
- 1 cardan
- 1 poignée coulissante
- 1 rallonge 125mm
- 1 rallonge Click'hold 280mm
- 2 douilles bougies 16 et 21 mm



Nb pièces	Dim mm	g	Ref.	EAN 330380+
28	405x225x60	4520	9436028001	9011725

Nb pièces	Dim mm	g	Ref.	EAN 330380+
28	405x225x60	4525	9436028101	9460073



9



69



103



129



133



155



187



197



223



231



257



273



277



283

CLIQUETS ET DOUILLES 1/4" - 1/2"

COFFRETS

CARGO DOUILLES 70 PIÈCES



PRATIQUE

- Le coffret mixte 1/4"-1/2" Fusion Box est équipé de rails qui permettent d'accrocher des coffrets en textile garni d'outils. Cela permet d'avoir une grande gamme de douilles bien rangées, complétées par la souplesse d'un sac textile détachable.

> Voir gamme Chapitre Rangement page 48

OUVERTURES

- Les coffrets peuvent s'ouvrir lorsqu'ils sont sur le Cargo.
- Le Cargo s'ouvre lui-même avec des coffrets accrochés sans déformation.
- Ses charnières triples sont renforcées par un jonc métal traversant.
- Coffret en Polyéthylène Haute Densité (PEHD).
- Fermoirs métalliques résistants.
- Mousse haute densité bicolore, idéale pour repérer les manquants



FUSION BOX CARGO - 1/4"-1/2" 70 PIÈCES

1/4": 10 douilles // 1 cliquet // 1 cardan //
2 rallonges // 1 poignée coulissante //
1 poignée tournevis //
1 douille porte-embouts // 30 embouts

1/2": 16 douilles // 1 cliquet // 1 cardan //
2 rallonges // 1 poignée coulissante //
2 douilles à bougie

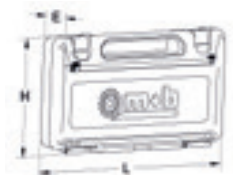

 9200 : 72 dents	 929A	 9202 : 72 dents	 9281 : 16 et 21 mm	 9283 : 160 mm	 9190 : x7: T10 - T15 - T20 - T25 - T27 - T30 - T40
 9210 : x 10 : 4 - 5 - 6 - 7 - 8 - 9 - 10 - 11 - 12 - 13 mm	 926 : 75 mm 140 mm avec bague déverrouillage	 9212 : x 16 : 10 - 11 - 12 - 13 - 14 - 15 - 16 - 17 - 18 - 19 - 21 - 22 - 24 - 27 - 30 - 32 mm	 9267 : 280 mm	 919A : x5 : 4 - 4,5 - 5,5 - 6,5 - 8,0 mm	 919G : TT10 - TT20
 9250	 9270 : 115 mm	 9252	 9272 : 255 mm	 919B : x4 : PH0 - PH1 - PH2 - PH3	 919E : x8 : 1,5 - 2 - 2,5 - 3 - 4 - 5 - 6 - 8 mm
			 9262 : 125 mm	 919C : x4 : P20 - P21 - P22 - P23	

L mm
70 pcs

Dim mm
600x330x90

kg
6,3

Ref.
9476070001

1

EAN 330380+
9006134

CLIQUETS ET DOUILLES 1/4" - 1/2"

COFFRETS

COFFRET BOX 1/4"-1/2" 33 PIÈCES 6 PANS CLIQUETS RONDS

1/4" : 10 douilles : 4/5/6/7/8/9/10/11/12/13 mm // 1 cliquet Premium rond // 1 cardan // 1 rallonge : 50 mm // 1 rallonge : 140 mm click'n hold -1/2" : 15 douilles : 10/11/12/13/14/16/17/18/19/21/22/24/27/30/32 mm // 1 cliquet Premium rond // 1 cardan // 1 rallonge : 125 mm / 1 rallonge : 280 mm click'n hold



Nb pièces	Dim mm	g	Ref.		EAN 330380+
33	405x225x60	3910	9436033001	1	9004512

COFFRET BOX 1/4"- 1/2" 33 PIÈCES CLIQUETS POIRES - POUCE

1/4" : 10 douilles : 3/16-7/32-1/4-9/32-5/16-11/32-3/8-7/16-1/2-9/16" // 1 cliquet poire // 1 cardan // 1 rallonge : 75 mm // 1 rallonge : 140 mm klik'n hold 1/2" : 15 douilles : 3/8-7/16-1/2-9/16-5/8-21/32-11/16-3/4-13/16-7/8-15/16-1-1/16-1 3/16-1 1/4" // 1 cliquet poire // 1 cardan // 1 rallonge : 125 mm / 1 rallonge : 280 mm klik'n hold



Nb pièces	Dim mm	g	Ref.		EAN 330380+
33	405x225x60	3900	9436033201	1	9013378

COFFRET PLASTIQUE TAMPER TORX 1/4"-1/2" 28 PIÈCES

1/4" : 7 douilles tournevis Tamper Torx : TT8, TT9, TT10, TT15, TT20, TT25, TT27 / 7 douilles Torx femelle : E4, E5, E6, E7, E8, E10, E11 // 1/2" : 7 douilles tournevis Tamper Torx : TT30, TT40, TT45, TT50, TT55, TT60, TT70 / 7 douilles Torx femelle : E11, E12, E14, E16, E18, E20, E24



Nb pièces	Dim mm	g	Ref.		EAN 401613+
28	260x175x60	1690	9028000000	1	4902635

COFFRET MÉTALLIQUE MIXTE 1/4"-1/2" 52 PIÈCES CLIQUET ROND

• Carré 1/4" : 12 douilles 6 pans de 4 à 13 mm // 1 cliquet rond // 1 cardan // 1 poignée coulissante // 2 rallonges // 1 poignée emmanchée // 1 douilles porte-embouts // 10 embouts de vissage // Carré 1/2" : 16 douilles 12 pans de 10 à 32 mm // 2 douilles à bougie 16 et 21 mm // 1 cliquet rond // 1 cardan // 2 rallonges // 1 poignée coulissante



Nb pièces	g	Ref.		EAN 330380+
52	6400	9413010001	1	9413017



9



69



103



129



133



155



187



197



223



231



257



273



277



283



283

CLIQUETS ET DOUILLES TRAVERSANTS

CLIQUETS ET COFFRETS

CLIQUETS ET DOUILLES TRAVERSANTS

PRÉCISION - RAPIDITÉ - ERGONOMIE

- Grâce à sa forme innovante, ce cliquet à tête traversante et les douilles et rallonges associées permettent d'atteindre les endroits les plus inaccessibles : les tiges filetées traversent douilles et cliquet et ne gênent plus le serrage.
- Plus rapide que des clés à pipe débouchées : l'angle de reprise de 5° permet de serrer rapidement dans les espaces restreints.



PRATIQUE

- 2 cliquets en 1.
- Grâce à ses 2 adaptateurs, le cliquet s'adapte à toutes les douilles traditionnelles.



CLIQUET À TÊTE TRAVERSANTE «MEDIUM»



L mm	ØD mm	H mm	g	Ref.	Ref.	EAN 330380+
205	32,5	11,5	250	9230010001	1	9230010

COFFRET DE DOUILLES TRAVERSANTES 14 PIÈCES

- 10 douilles : 10-11-12-13-14-15-16-17-18-19 mm
- 1 cliquet traversant medium
- 1 rallonge 75 mm
- 2 adaptateurs

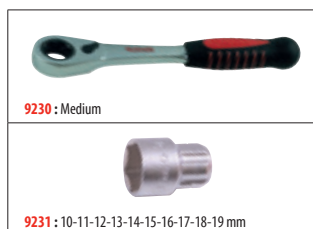

9230 : Medium

9231 : 10-11-12-13-14-15-16-17-18-19 mm



9232 : L 75 mm

9233 : 1/4"

9233 : 3/8"

Nb pièces	Dim mm	g	Ref.	Ref.	EAN 330380+
14	270X215X60	1150	9400010001	1	9400000

COFFRET DE DOUILLES TRAVERSANTES 59 PIÈCES MIXTE

Coffret PEHD - mousse bicolore

Small : 13 douilles traversantes : 4 à 14 mm

- 1 cliquet traversant
- 1 rallonge 75 mm
- 1 douille porte embout pour cliquet
- 1 poignée tournevis
- 1 douille porte embout
- 24 embouts

Medium : 13 douilles traversantes 10 à 22mm

- 1 cliquet traversant
- 1 rallonge 75 mm
- 2 adaptateurs



Nb pièces	Dim mm	g	Ref.	Ref.	EAN 330380+
59	350x265x75	2350	9470059001	1	9009708

CLIQUETS ET DOUILLES 3/4"

DOUILLES, ACCESSOIRES, COFFRETS

CLIQUETS ET DOUILLES 3/4"

COMPACTITÉ

- Accès aux environnements restreints facilité : reprise de 9° (40 dents).
- Inverseur de sens encastré : changement contrôlé et d'une seule main.
- Manche démontable.



DOUILLES

- Douilles montées avec un plongeur «lock pin» : permet de solidariser la douille de l'élément (rallonge, cliquet).

RAYON DE PROTECTION DU CARRÉ

- Rayon de protection qui permet de répartir la charge et évite que la douille se casse.



CLIQUET POIRE 3/4"

Vrac

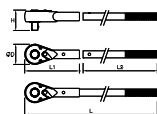

L mm	I1 mm	I2 mm	ØD mm	H mm	g	Ref.	Ref.	EAN 330380+
505	155	385	62,5	57	2800	9203400101	1	9001542

DOUILLE 6 PANS 3/4"

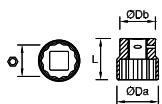

Dim mm	L mm	ØDa mm	ØDb mm	g	Ref.	Ref.	EAN 330380+
22	50	32	36	215	9213220001	1	9000972
24	51	34	36	230	9213240001	1	9000996
27	52	38	36	250	9213270001	1	9001023
28	52	39	36	250	9213280001	1	9001030
29	52	40	36	275	9213290001	1	9001047
30	54	42	36	275	9213300001	1	9001054
32	56	44	36	295	9213320001	1	9001078
33	56	46	36	340	9213330001	1	9001207
36	58	50	38	410	9213360001	1	9001337
38	60	52	38	465	9213380001	1	9001344
41	64	56	40	545	9213410001	1	9001368
46	66	62	42	640	9213460001	1	9001382
50	70	68	42	770	9213500001	1	9001399
55	76	74	45	770	9213550001	1	9001405

DOUILLE 6 PANS 3/4" SUR CARTE



Dim mm	L mm	g	Ref.	Ref.	EAN 330380+
22	50	215	9213221001	1	0008823
24	51	230	9213241001	1	0008830
27	52	250	9213271001	1	0008700
30	54	275	9213301001	1	0008717
32	56	295	9213321001	1	0008847
36	58	410	9213361001	1	0008854
41	64	545	9213411001	1	0008724
46	66	640	9213461001	1	0008731
50	70	770	9213501001	1	0008748

DOUILLE 12 PANS 3/4"

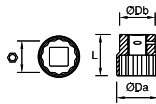

Dim mm	L mm	ØDa mm	ØDb mm	g	Ref.	Ref.	EAN 330380+
22	51	33	36	215	9218220001	1	9000637
23	50	34	36	220	9218230001	1	9000644
24	52	34	36	230	9218240001	1	9000651
26	52	37	36	220	9218260001	1	9000668
27	52	38	36	250	9218270001	1	9000675
28	52	39	36	250	9218280001	1	9000682
29	53	42	38	275	9218290001	1	9000699
30	53	42	38	275	9218300001	1	9000729
32	56	44	38	295	9218320001	1	9000736
33	56	46	38	320	9218330001	1	9000743
35	58	48	42	380	9218350001	1	9000750
36	57	50	42	410	9218360001	1	9000767
38	60	53	45	465	9218380001	1	9000774
40	62	54	45	495	9218400001	1	9000781
41	64	56	45	545	9218410001	1	9000798
42	64	57	45	550	9218420001	1	9000828
46	68	62	47	640	9218460001	1	9000835
50	72	69	49	770	9218500001	1	9000842
55	72	69	49	770	9218550001	1	9000859

CARDAN UNIVERSEL DOUILLE 3/4"

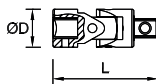

L mm	ØD mm	g	Ref.	Ref.	EAN 330380+
143	40	600	9253000001	1	9000538

CARDAN UNIVERSEL DOUILLE 3/4" SUR CARTE



L mm	ØD mm	g	Ref.	Ref.	EAN 330380+
143	40	600	9253001001	1	0008861

CLIQUETS ET DOUILLES 3/4"

DOUILLES, ACCESSOIRES, COFFRETS

ADAPTATEURS



L mm	ØD mm	g	Ref.	Ref.	EAN 330380+
3/4" => 1/2"	54	34	175	9293120001	1 9000491
3/4" => 1"	54	34	175	9293100001	1 9000514

ADAPTATEURS 3/4" A 1/2" SUR CARTE

3/4" à 1/2"



L mm	ØD mm	g	Ref.	Ref.	EAN 330380+
3/4" => 1/2"	54	34	175	9293121001	1 0008779

RALLONGE CARRÉ 3/4"



L mm	ØD mm	g	Ref.	Ref.	EAN 330380+
200	36	715	9263200001	1	9000552
400	36	1350	9263400001	1	9000576

RALLONGE CARRÉ 3/4" SUR CARTE



L mm	ØD mm	g	Ref.	Ref.	EAN 330380+
200	36	715	9263201001	1	0008755
400	36	1350	9263401001	1	0008762

POIGNÉE COULISSANTE 3/4"

Vrac

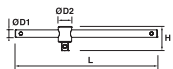

L mm	ØD1 mm	ØD2 mm	H mm	g	Ref.	Ref.	EAN 330380+
455	20	37	60	1380	9273450001	1	9000590

COFFRET MÉTALLIQUE 3/4" 16 PIÈCES, 6 PANS

- 10 douilles : 22-24-27-30-32-36-38-41-46-50 mm
- 1 cliquet 40 dents // 1 cardan
- 1 poignée coulissante // 2 rallonges 200-400 mm
- 1 adaptateur 3/4"-1/2"



L mm	Nb pièces	kg	Ref.	Ref.	EAN 330380+
6-kant	16	14	9440020001	1	9003409

COFFRET MÉTALLIQUE 3/4" 16 PIÈCES, 12 PANS

- 10 douilles : 22-24-27-30-32-36-38-41-46-50 mm
- 1 cliquet 40 dents // 1 cardan
- 1 poignée coulissante // 2 rallonges 200-400 mm
- 1 adaptateur 3/4"-1/2"



Nb pièces	kg	Ref.	Ref.	EAN 330380+
16	14	9440010001	1	9000453

CLIQUETS ET DOUILLES 1"

COMPACITÉ

- Cliquet 36 dents soit une reprise de 10°, pour un accès aux environnements restreints facilité.
- Inverseur de sens encasté : changement contrôlé et d'une seule main.
- Manche démontable.

DOUILLES

- Douilles montées avec un plongeur «lock pin» : permet de solidariser la douille de l'élément (rallonge, cliquet).



CLIQUET POIRE 1"

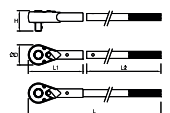

L mm	L1 mm	L2 mm	ØD mm	H mm	g	Ref.	Ref.	EAN 330380+
675	205	538	70	67	5600	9204360101	1	9001559

CLIQUETS ET DOUILLES 1"

DOUILLES, ACCESSOIRES, COFFRETS

DOUILLE 6 PANS 1"

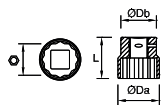

Dim mm	L mm	ØDa mm	ØDb mm	g	Ref.	Ref.	EAN 330380+
36	65	53	45	480	9214360001	1	9001429
41	71	57	45	570	9214410001	1	9001436
46	76	65	50	805	9214460001	1	9001443
55	81	77	57	1145	9214550001	1	9001467
60	84	82	57	1285	9214600001	1	9001474
65	89	89	57	1490	9214650001	1	9001481
70	94	94	68	1895	9214700001	1	9001498
75	98	100	68	2140	9214750001	1	9001504
80	104	105	68	2285	9214800001	1	9001528

DOUILLE 12 PANS 1"

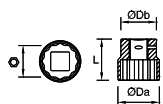

Dim mm	L mm	ØDa mm	ØDb mm	g	Ref.	Ref.	EAN 330380+
36	65	53	45	480	9219360001	1	9000866
41	71	57	45	570	9219410001	1	9000873
46	76	65	50	805	9219460001	1	9000880
55	81	77	57	1145	9219550001	1	9000903
60	84	82	57	1285	9219600001	1	9000927
65	89	89	57	1490	9219650001	1	9000934
75	98	100	68	2140	9219750001	1	9000958
80	104	105	68	2285	9219800001	1	9000965

CARDAN UNIVERSEL DOUILLE 1"

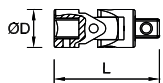

L mm	ØD mm	g	Ref.	Ref.	EAN 330380+
143	49	750	9254000001	1	9000545

ADAPTATEUR 1" A 3/4"

1" à 3/4"



L mm	ØD mm	g	Ref.	Ref.	EAN 330380+
68	48	425	9294340001	1	9000521

RALLONGE CARRÉ 1"



L mm	ØD mm	g	Ref.	Ref.	EAN 330380+
200	48	1300	9264200001	1	9000569
400	48	2300	9264400001	1	9000583

POIGNÉE COULISSANTE 1"

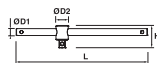

L mm	ØD1 mm	ØD2 mm	H mm	g	Ref.	Ref.	EAN 330380+
550	28	49	80	3300	9274550001	1	9000620

COFFRET MÉTALLIQUE 1" 17 PIÈCES, 6 PANS

- 10 douilles : 36-41-46-50-55-60-65-70-75-80 mm
- 1 cliquet 36 dents // 1 cardan
- 1 poignée coulissante // 2 rallonges 200-400 mm
- 1 adaptateur 1"-3/4"

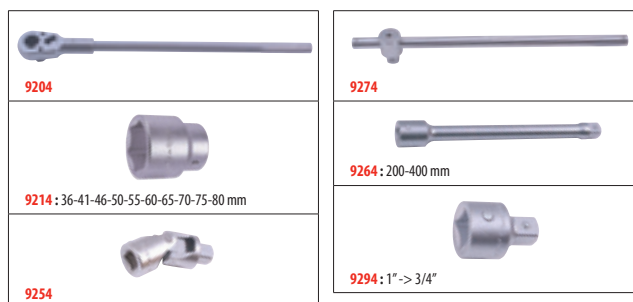

L mm	Nb pièces	kg	Ref.	Ref.	EAN 330380+
6-kant	17	34	9450200001	1	9003416

COFFRET MÉTALLIQUE 1" 17 PIÈCES, 12 PANS

- 10 douilles : 36-41-46-50-55-60-65-70-75-80 mm
- 1 cliquet 36 dents // 1 cardan
- 1 poignée coulissante // 2 rallonges 200-400 mm
- 1 adaptateur 1"-3/4"

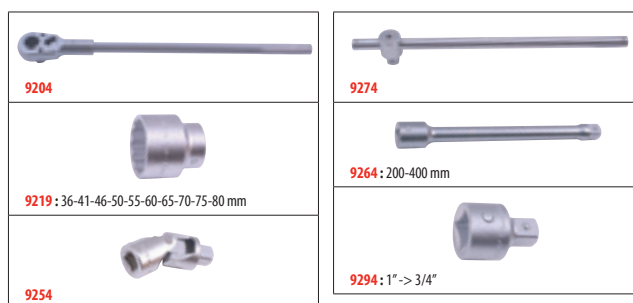

Nb pièces	kg	Ref.	Ref.	EAN 330380+
17	34	9450010001	1	9000460



9



69



103



129



133



155



187



197



223



231



257



273



277



283

CLIQUETS ET DOUILLES IMPACT

DOUILLES, ACCESSOIRES, COFFRETS

DOUILLES IMPACT

QUALITÉ

- Acier de qualité et traitement thermique garantissant une très grande résistance et une longue durée de vie.

- Conçues pour résister aux contraintes des outils électroportatifs : clés à chocs, visseuses, ...

Nota : la goupille et le joint ne sont pas livrés avec les produits.



CARRÉ 1/2"

DOUILLES IMPACT 6 PANS 1/2"

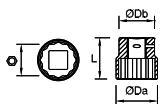

Dim mm	ØDb mm	ØDa mm	L mm	g	Ref.	Ref.	EAN 330380+
8	25	15	38	65	9212080501	1	1700528
10	25	17	38	65	9212100501	1	1700993
13	25	21	38	75	9212130501	1	1700955
14	25	22.5	38	80	9212140501	1	1700443
15	30	23	38	110	9212150501	1	1700658
16	30	25	38	450	9212160501	1	1700917
17	30	26	38	120	9212170501	1	1700412
18	30	27.5	38	120	9212180501	1	1700627
19	30	28.5	38	120	9212190501	1	1700894
21	30	31	38	130	9212210501	1	1700597
22	30	32.5	38	140	9212220501	1	1700856
24	30	35	38	145	9212240501	1	1700566
27	30	38.5	45	200	9212270501	1	1700535
30	30	42	50	255	9212300501	1	1700498
32	30	44	50	270	9212320501	1	1700962

DOUILLES IMPACT LONGUES 6 PANS 1/2"



Dim mm	ØDb mm	ØDa mm	L mm	g	Ref.	Ref.	EAN 330380+
10	25	17	80	135	9222100501	1	1700863
11	25	18.5	80	140	9222110501	1	1701068
13	25	21	80	160	9222130501	1	1700801
14	25	22.5	80	170	9222140501	1	1701044
16	30	25	80	230	9222160501	1	1700757
17	30	26	80	240	9222170501	1	1701006
18	30	27.5	80	255	9222180501	1	1700504
19	30	28.5	80	255	9222190501	1	1700733
21	30	31	80	285	9222210501	1	1700450
22	30	32.5	80	295	9222220501	1	1700665
24	30	35	80	360	9222240501	1	1700429
27	30	38.5	80	385	9222270501	1	1701082
28	30	40	80	420	9222280501	1	1700603
30	30	42	80	400	9222300501	1	1701075
32	30	44	80	470	9222320501	1	1700818

DOUILLES TOURNEVIS IMPACT DE TYPE HEXAGONAL 1/2"



Dim mm	ØDb mm	L mm	g	Ref.	Ref.	EAN 330380+
H5	25	44	66	929E050501	1	0012035
H6	25	44	67	929E060501	1	0012059
H8	25	44	72	929E080501	1	0012073
H10	25	44	76	929E100501	1	0012097
H12	25	44	79	929E120501	1	0012134
H14	25	44	85	929E140501	1	0012141
H17	25	44	97	929E170501	1	0012158
H19	25	44	105	929E190501	1	0012165

DOUILLES TOURNEVIS IMPACT DE TYPE TORX 1/2"



Dim mm	ØDb mm	L mm	g	Ref.	Ref.	EAN 330380+
T50	25	44	68	929D500501	1	0012172
T55	25	44	73	929D550501	1	0012189
T60	25	44	76	929D600501	1	0012196

CARDAN UNIVERSEL IMPACT 1/2"



L mm	ØD mm	g	Ref.	Ref.	EAN 330380+
58.5	30	170	9252000501	1	1701020

RALLONGE IMPACT 1/2"



L mm	ØD mm	g	Ref.	Ref.	EAN 330380+
75	25	130	9262070501	1	1701037
125	25	195	9262120501	1	1700719
250	25	355	9262250501	1	1700795

CLIQUETS ET DOUILLES IMPACT

DOUILLES, ACCESSOIRES, COFFRETS

ADAPTATEUR IMPACT 1/2" A 3/4"



ØF mm	ØM mm	L mm	ØD mm	g	Ref.	Ref.	Ref.	EAN 330380+
1/2"	3/4"	45	25	115	9292340501	1	1700931	

JONC+GOUPILLE DOUILLE 1/2 IMPACT

Pour verrouiller les douilles
Impact en toute sécurité.



L mm	g	Ref.	Ref.	EAN 330380+
8 -> 14 mm	5	9299140501	1	9008183
15 -> 32mm	5	9299990501	1	9008190

COFFRET MÉTALLIQUE DE DOUILLES IMPACT 1/2" 10 PIÈCES

Goupilles et joints fournis dans ce coffret



Contenu	L x l x H mm	g	Ref.	Ref.	EAN 330380+
x 10 : 10-11-12-13-14-17-19-21-22-24 mm	305x56x42	1290	9212010501	1	9007599

COFFRET MÉTALLIQUE DE DOUILLES IMPACT LONGUES 1/2" 10 PIÈCES

Goupilles et joints fournis dans ce coffret



Contenu	L x l x H mm	g	Ref.	Ref.	EAN 330380+
x 10 : 10-11-13-14-16-17-19-21-22-24 mm	325x160x50	3230	9222010501	1	0014626

COFFRET DE 3 DOUILLES IMPACT 1/2"

Douilles longues gainées



Contenu	g	Ref.	Ref.	EAN 330380+
17-19-21 mm	990	9430030501	1	9008954

CARRÉ 3/4"

DOUILLES IMPACT 3/4"



Dim mm	ØDb mm	ØDa mm	L mm	g	Ref.	Ref.	EAN 330380+
19	44	32.5	51	335	9213190501	1	1700573
22	44	36	51	350	9213220501	1	1700542
23	44	37.5	51	355	9213230501	1	1700764
24	44	38.5	51	360	9213240501	1	1701013
27	44	42.5	53	375	9213270501	1	1700979
28	44	44	53	385	9213280501	1	1700467
29	44	45	53	390	9213290501	1	1700672
30	44	46	53	395	9213300501	1	1700924
32	44	48.5	57	445	9213320501	1	1700634
33	44	50	57	465	9213330501	1	1700900
34	44	51	57	465	9213340501	1	1701099
35	44	52.5	57	485	9213350501	1	1700610
36	44	53.5	57	490	9213360501	1	1700870
38	44	56	57	515	9213380501	1	1700580
41	44	60	58	565	9213410501	1	1700559
42	44	61	58	575	9213420501	1	1700771
46	44	66	62	665	9213460501	1	1700986

DOUILLES IMPACT LONGUES 3/4"



Dim mm	ØDb mm	ØDa mm	L mm	g	Ref.	Ref.	EAN 330380+
17	44	30	90	500	9223170501	1	1700689
19	44	32.5	90	515	9223190501	1	1700436
22	44	36	90	555	9223220501	1	1701105
24	44	38.5	90	570	9223240501	1	1700887
27	44	42.5	90	635	9223270501	1	1700825
30	44	46	90	685	9223300501	1	1700788
32	44	48.5	90	730	9223320501	1	1700511
36	44	53.5	90	840	9223360501	1	1700696
41	44	60	90	930	9223410501	1	1701112
46	44	66	90	1110	9223460501	1	1700832

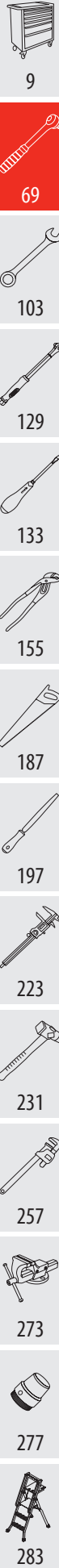

CLIQUETS ET DOUILLES IMPACT

DOUILLES, ACCESSOIRES

CARDAN UNIVERSEL IMPACT 3/4"



L mm	ØD mm	g	Ref.	Ref.	EAN 330380+
106	44	735	9253000501	1	1700702

RALLONGE IMPACT 3/4"



L mm	D mm	g	Ref.	Ref.	EAN 330380+
175	44	850	9263170501	1	1700849
250	44	1170	9263250501	1	1700474

ADAPTATEUR IMPACT 3/4" A 1" / 3/4" A 1/2"



ØF->ØM mm	L mm	ØD mm	g	Ref.	Ref.	EAN 330380+
3/4"->1"	63	44	425	9293100501	1	1700948
3/4"->1/2"	58	44	335	9293120501	1	1700641

ADAPTATEUR IMPACT 1" A 3/4"



ØF->ØM mm	L mm	ØD mm	g	Ref.	Ref.	EAN 330380+
1"->3/4"	66	54	630	9294340501	1	1701051

JONC+GOUPILLE DOUILLE 3/4 IMPACT



Pour verrouiller les douilles Impact en toute sécurité



L mm	g	Ref.	Ref.	EAN 330380+
19->46 mm	5	9299460501	1	9000989

CARRÉ 1"

DOUILLES IMPACT 1"



Dim mm	ØDb mm	ØDa mm	L mm	g	Ref.	Ref.	EAN 330380+
22	51	39	58	500	9214220501	1	0012202
24	51	44	58	505	9214240501	1	0012219
27	51	44	58	505	9214270501	1	0012226
29	51	46	60	535	9214290501	1	0012233
30	51	48	60	540	9214300501	1	0012240
32	51	51	62	580	9214320501	1	0012257
33	51	51	62	620	9214330501	1	0012264
34	54	54	62	675	9214340501	1	0012271
35	54	54	62	680	9214350501	1	0012288
36	54	56	62	680	9214360501	1	0012295
38	54	58	62	690	9214380501	1	0012301
41	54	62	62	750	9214410501	1	0012318
42	54	63	64	800	9214420501	1	0012325
46	54	63	64	870	9214460501	1	0012332
50	54	73	70	1065	9214500501	1	0012356
55	54	79	71,5	1210	9214550501	1	0012363
60	54	87	78	1530	9214600501	1	0012370
65	54	93	80	1670	9214650501	1	0012387
70	54	98	84	1920	9214700501	1	0012394
75	86	104	95	3335	9214750501	1	0012400

CARDAN UNIVERSEL IMPACT 1"



L mm	ØD mm	g	Ref.	Ref.	EAN 330380+
113,5	54	1030	9254000501	1	0012431

RALLONGE IMPACT 1"



L mm	D mm	g	Ref.	Ref.	EAN 330380+
250	54	1930	9264250501	1	0012417
330	54	2500	9264330501	1	0012424

JONC+GOUPILLE DOUILLE 1" IMPACT



Pour verrouiller les douilles Impact en toute sécurité



L mm	g	Ref.	Ref.	EAN 330380+
22->33 mm	14	9299220501	1	9300249
34->70 mm	15	9299340501	1	9300256
75 mm	43	9299750501	1	9300232